

Mitlaufende Körnerspitze – Komplett-Set mit auswechselbaren Einsätzen

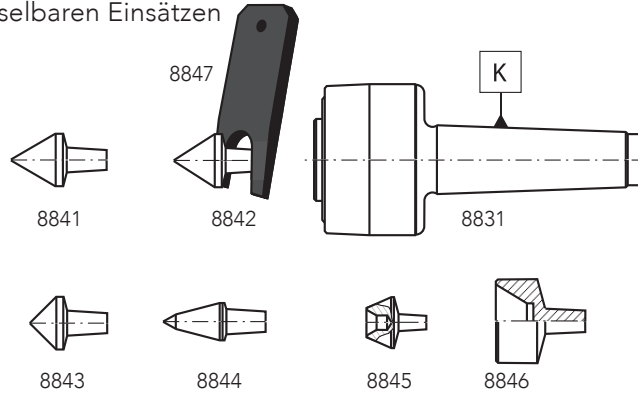

Typ 8831-KPL

Mitlaufende Körnerspitze – Komplett-Satz mit auswechselbaren Einsätzen



K MK	Gewicht max.	U/min.	Rundlaufabweichung		Artikel Nr.	Rundlaufabweichung		Artikel Nr.
			Präzision	Standard		Standard	Standard	
2	70	5000	0,010		800002610	0,020		800002611
3	120	4000			800002612			800002613
4	280	3000			800002614			800002615
5	650	2500	0,015		800002616	0,030		800002617
6	1200	2000			800002618			800002619

Typ 8841

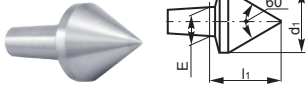

Artikel Nr.	W*	d1	E	l1
800002660	2	18	7	21,0
800002661	3	25	12	28,0
800002662	4	28	15	30,5
800002663	5	40	22	42,5
800002664	6	60	28	61,5

*Grösse

Typ 8842



Artikel Nr.	W*	d1	E	l1
800002665	2	18	7	17,5
800002666	3	25	12	23,0
800002667	4	28	15	25,0
800002668	5	40	22	34,0
800002669	6	60	28	50,5

Typ 8843

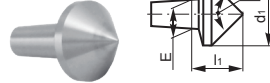

Artikel Nr.	W*	d1	E	l1
800002670	2	18	7	15,0
800002671	3	25	12	19,0
800002672	4	28	15	21,0
800002673	5	40	22	28,0
800002674	6	60	28	40,0

Typ 8844

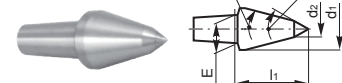

Artikel Nr.	W*	d1	d2	E	l1
800002675	2	15	6	7	27,0
800002676	3	18	8	12	31,0
800002677	4	25	12	15	40,5
800002678	5	28	13	22	45,5
800002679	6	40	18	28	63,5

Typ 8845

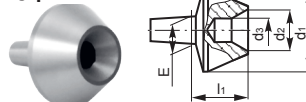

Artikel Nr.	W*	d1	d2	d3	E	l1
800002680	2	28	12	6	7	18,5
800002681	3	40	19	10	12	24,0
800002682	4	55	22		15	36,5
800002683	5	70	32		22	42,0
800002684	6	100	50	15	28	56,0

Typ 8846

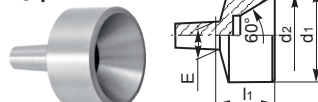

Artikel Nr.	W*	d1	d2	E	l1
800002904	2	28	24	7	21,5
800002905	3	40	35	12	26,5
800002906	4	55	48	15	39,0
800002907	5	70	63	22	47,0
800002908	6	100	90	28	62,0

Typ 8847

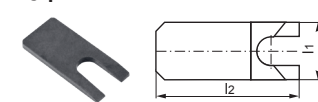

Artikel Nr.	W*	l1	l2
800002909	2	20	50
800002910	3	30	70
800002911	4	45	100
800002912	5	55	120
800002913	6	65	160

Mitlaufende Körnerspitze – Komplet-Set mit auswechselbaren Einsätzen



Typ 8832-KPL

Mitlaufende Körnerspitze – Komplet-Satz mit auswechselbaren Einsätzen

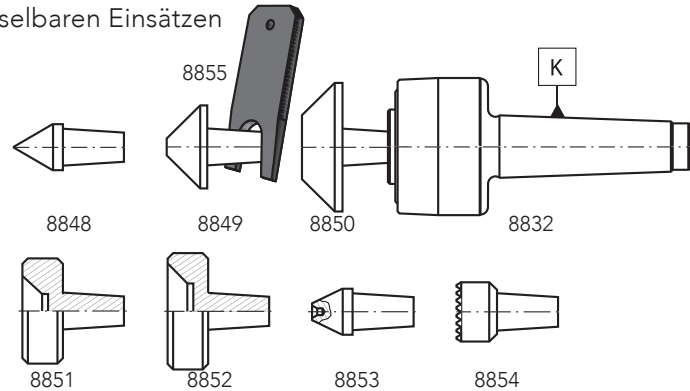

K MK	Gewicht max.	U / min.	Rundlaufabweichung		Artikel Nr.	
			Präzision	Standard	Präzision	Standard
2	70	5000	0,010	0,020	800002635	800002636
3	120	4000			800002637	800002638
4	280	3000			800002639	800002640
5	650	2500	0,015	0,030	800002641	800002642
6	1200	2000			800002643	800002644

Typ 8848

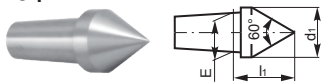

Artikel Nr.	W*	d1	E	l1
800002914	2	15	10	19
800002915	3	20	15	25
800002916	4	25	20	30
800002917	5	32	25	35
800002918	6	36	30	44

Typ 8849

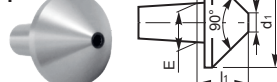

Artikel Nr.	W*	d1	d2	E	l1
800002919	2	22	3	10	15
800002920	3	36	6	15	22
800002921	4	45	10	20	25
800002922	5	56	14	25	30
800002923	6	70	18	30	36

*Grösse

Typ 8850

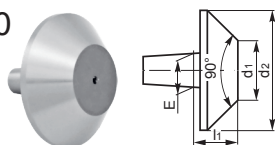

Artikel Nr.	W*	d1	d2	E	l1
800002924	2	18	37	10	15
800002925	3	33	63	15	22
800002926	4	35	70	20	25
800002927	5	38	80	25	30
800002928	6	50	100	30	36

Typ 8851

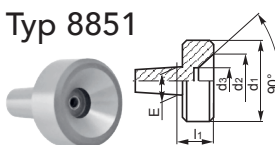

Artikel Nr.	W*	d1	d2	d3	E	l1
800002929	2	22	18	8	10	15
800002930	3	36	28	12	15	22
800002931	4	45	37	17	20	25
800002932	5	56	44	20	25	30
800002933	6	70	58	24	30	36

Typ 8852

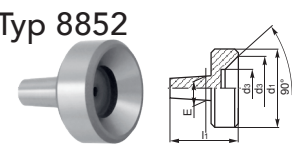

Artikel Nr.	W*	d1	d2	d3	E	l1
800002934	2	30	25	15	10	15
800002935	3	45	38	22	15	22
800002936	4	63	53	30	20	25
800002937	5	70	60	36	25	30
800002938	6	100	88	54	30	36

Typ 8853



Artikel Nr.	W*	d1	E	l1
800002914	2	15	10	19
800002915	3	20	15	25
800002916	4	25	20	30
800002917	5	32	25	35
800002918	6	36	30	44

Typ 8854

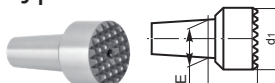

Artikel Nr.	W*	d1	E	l1
800002944	2	18	10	15
800002945	3	25	15	22
800002946	4	32	20	25
800002947	5	45	25	30
800002948	6	56	30	36

Typ 8855

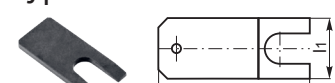

Artikel Nr.	W*	l1	l2
800002949	2	20	60
800002950	3	30	80
800002951	4	40	100
800002952	5	50	120
800002953	6	60	160